

FEATURES

- LOWER ESR - HIGH Q at HIGH FREQUENCY
- STABLE NPO CHARACTERISTICS OVER TEMPERATURE AND VOLTAGE
- EIA 0201, 0402, 0603 & 0805 CASE SIZES
- WIDE CAPACITANCE (UP TO 3,300pF) & VOLTAGE RANGE (UP TO 100VDC)

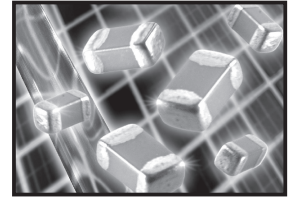

SPECIFICATIONS	NPO			
	0201	0402	0603	0805
Case Sizes	0201	0402	0603	0805
Capacitance Range*	1.0pF ~ 15pF	0.5pF ~ 470pF	0.5pF ~ 3300pF	1.0pF ~ 150pF
Capacitance Tolerance	Cap. Values ≤ 5pF: ±0.1pF(B), ±0.25pF(C) Cap. Values 5pF ~ 8.2pF: ±0.25pF(C), ±0.5pF(D) Cap. Values ≥ 10pF: ±1%(F), ±2%(G), ±5% (J)			
Operating Temperature Range	-55°C ~ +125°C			
Temperature Characteristics	0 ± 30PPM/°C			
Rated Voltage	16Vdc, 25Vdc, 50Vdc		16Vdc, 25Vdc, 50Vdc & 100Vdc	
Q Factor*	Cap. Values < 30pF: Q ≥ 400 + 20C Cap. Values ≥ 30pF: Q ≥ 1000			
ESR	Cap. Values < 2.2pF: ≤ 1000mΩ@900MHz ± 100MHz Cap. Values 2.2pF ~ 470pF: ≤ 500mΩ@900MHz ± 100MHz Cap. Values > 470pF: ≤ 500mΩ@60MHz ± 10MHz			
Insulation Resistance	10,000 Megohms min. @ +25°C			
Dielectric Withstanding Voltage	250% of rated voltage for 1 ~ 5 seconds			
Test Conditions (Cap. & Q)	*1.0 ± 0.2Vrms, 1MHz ± 10% (≤ 1000pF) or 1KHz ± 10% (> 1000pF)			

RoHS Compliant

Includes all homogeneous materials

*See Part Number System for Details

Note: Reflow soldering allowed for all case sizes. Contact NIC for wave soldering restrictions.

EIA Case Size	0201	0402	0603	0805
Length (L)	0.6 ± 0.05	1.0 ± 0.05	1.6 ± 0.10	2.0 ± 0.10
Width (W)	0.3 ± 0.05	0.5 ± 0.05	0.8 ± 0.10	1.25 ± 0.10
Thickness (T)	0.33 max.	0.60 max.	1.0 max.	1.3 max.
Termination Width (P)	0.10 ~ 0.20	0.15 ~ 0.30	0.12 ~ 0.55	0.25 ~ 0.71

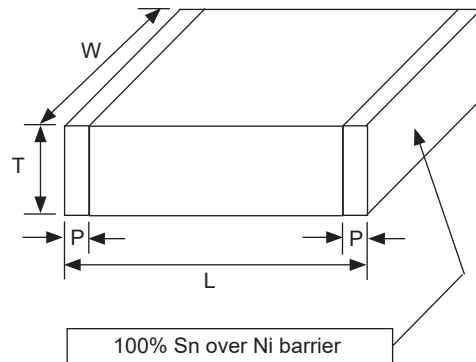

PART NUMBER SYSTEM

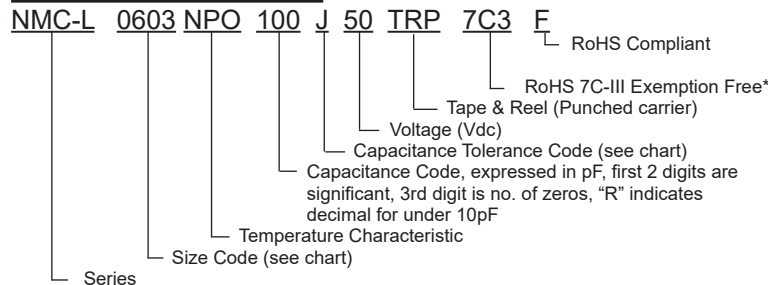

* - Part Number Level Identification of NPO MLCCs that do not take RoHS exemption 7C-III

Multilayer Ceramic Chip Capacitors

NMC-L Series

EIA Case Size	0201	0402			0603			0805			
2.0	0.6 ± 0.05	1.0 ± 0.05			1.6 ± 0.10			2.0 ± 0.1			
Width (W)	0.3 ± 0.05	0.5 ± 0.05			0.8 ± 0.10			1.25 ± 0.1			
Thickness max. (T)	0.33 max	0.55 max.			0.87 max.			1.30 max.			
Termination Width (P)	0.10 ~ 0.20	0.15 ~ 0.30			0.25 ~ 0.55			0.25 ~ 0.71			
Capacitance (pF)	Working Voltage (Vdc)										
	25V	16	25	50	100	16	25	50	100	50	100
0.5											
0.6											
0.7											
0.8											
0.9											
1.0											
1.2											
1.5											
1.8											
2.2											
2.7											
3.3											
3.9											
4.7											
5.6											
6.8											
8.2											
10											
12											
15											
18											
22											
27											
33											
39											
47											
56											
68											
82											
100											
110											
120											
130											
150											
180											
220											
270											
330											
390											
470											
560											
680											
820											
1,000											
1,200											
1,500											
1,800											
2,200											
2,700											
3,300											

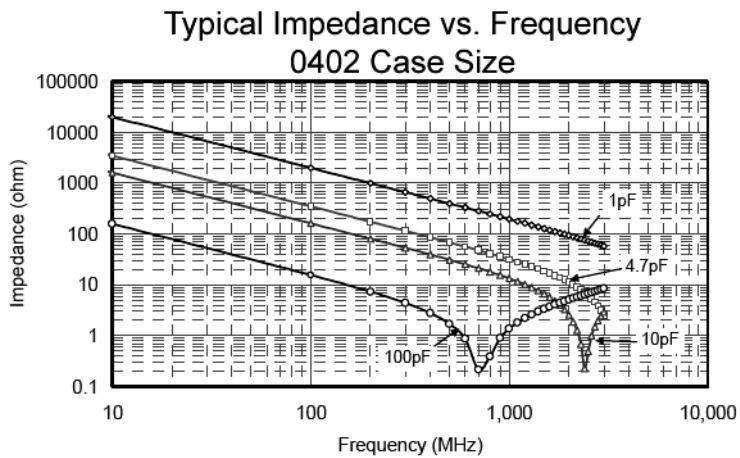
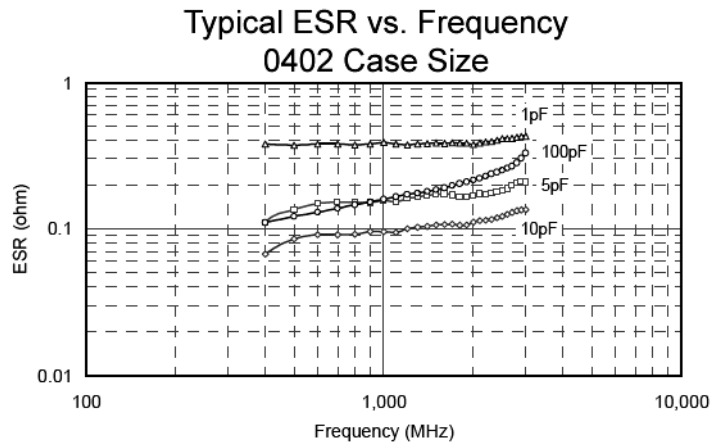
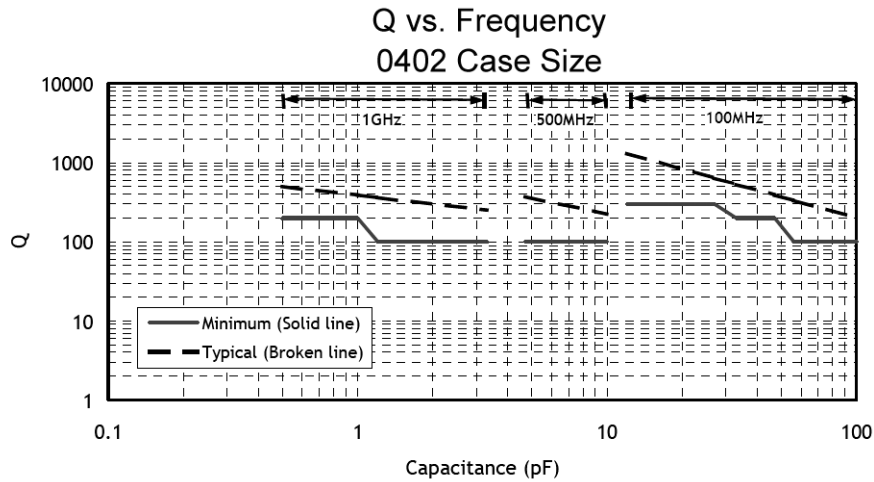

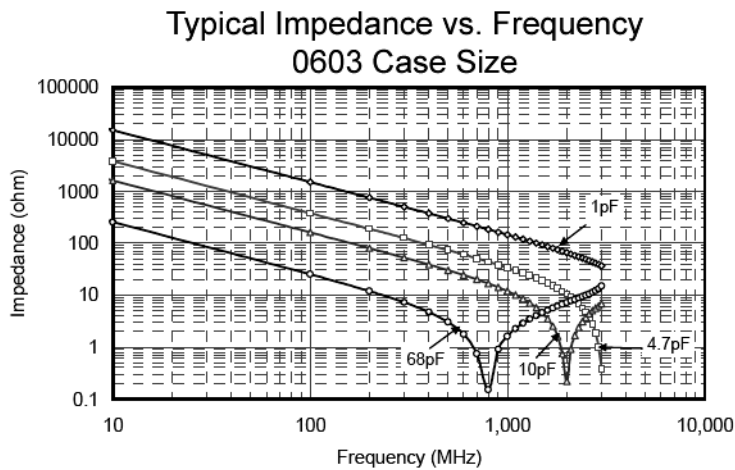
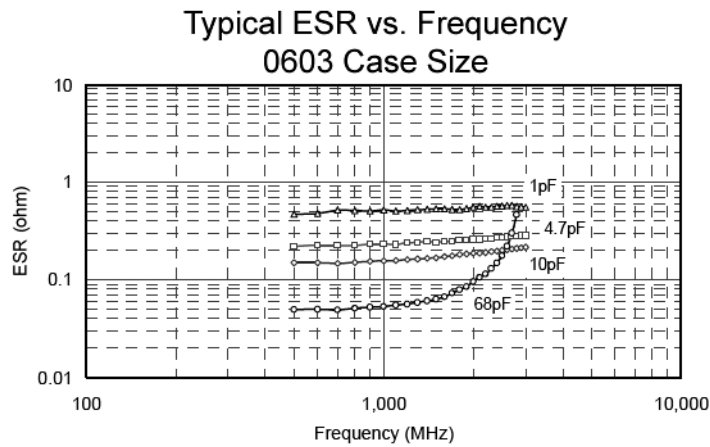
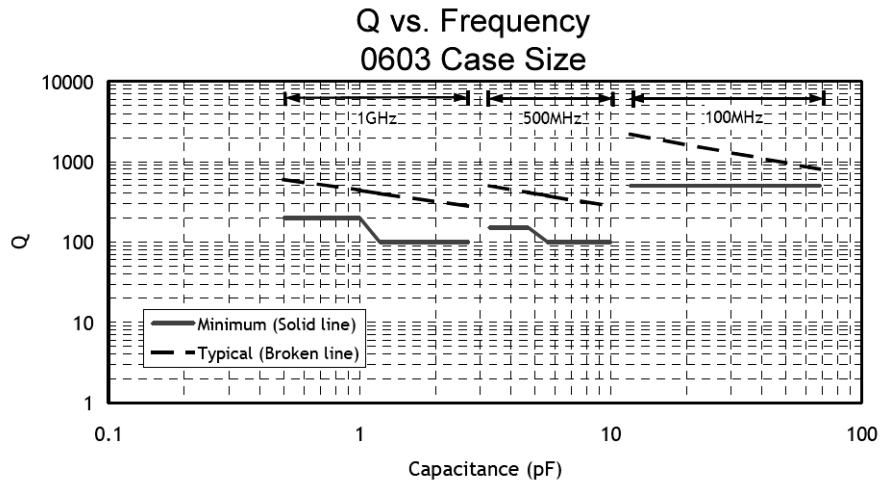

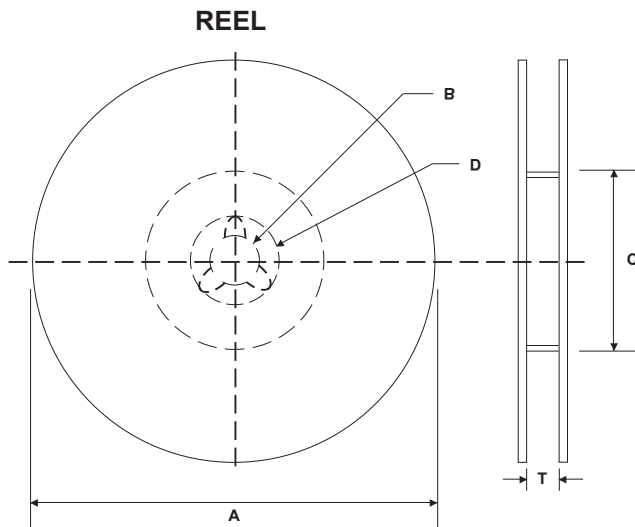

REEL DIMENSIONS (mm)

Reel Diameter (A)	B	C	D	T max.
7" (178 ± 2.0)	13 ± 0.5	50 min.	21 ± 1.0	8.4 +1.0/-0 (1812 case size 12.4 +2.0/-0)
10" (250 ± 2.0)		100 ± 1.0		
13" (330 ± 2.0)		100 ± 1.0		

7 INCH REEL QUANTITIES*

Size	01005	0201	0402	0603	0805	1206	1210	1812
Tape Size	8mm	8mm	8mm	8mm	8mm	8mm	8mm	12mm
Min. Qty Per Reel	20,000	20,000	10,000	4,000	4,000	4,000	2,000	1,000
Max. Qty Per Reel	20,000	20,000	10,000	4,000	5,000	5,000	5,000	2,000

*Quantity dependent on chip thickness. Contact NIC for reel quantities on larger diameter reels.

CARRIER TAPE MATERIAL

Parts with a thickness of $\geq 1\text{mm}$ will be taped on embossed plastic carrier. Parts with a thickness of less than 1mm will be taped on paper carrier

EMBOSSED PLASTIC CARRIER TAPE DIMENSIONS (mm)

Tape Size	W	F	E	P ₀	P ₂	D	K max.	T max.	P
8mm	8.0 ± 0.2	3.5 ± 0.05	1.75 ± 0.10	4.0 ± 0.1	2.0 ± 0.5	1.5 ^{+0.1} _{-0.0}	3.0	2.0	4.0 ± 0.1
12mm	12 ± 0.2	5.5 ± 0.05						4.5	8.0 ± 0.1

Notes:

- Specifications are in compliance with EIA RS481-1-A "Taping of Surface Mount Components for Automatic Placement"
- Dimensions A₀ (max.) equals component width dimension plus 0.5mm
- Dimension B₀ (max.) equals component length dimension plus 0.5mm

EMBOSSED PLASTIC CARRIER TAPE

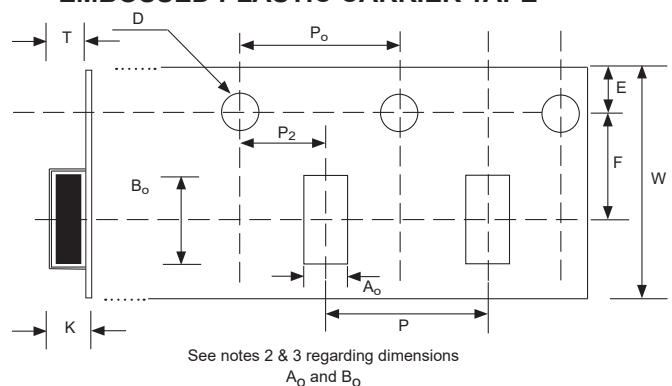

PUNCHED CARRIER TAPE DIMENSIONS (mm)

Type	A ₀	B ₀	W	F	E	P1	P0	D0	T1 max.	T2 max.	Mounting Hole
01005	0.25 ± 0.04	0.45 ± 0.04	8.0 ± 0.3	3.5 ± 0.05	1.75 ± 0.1	2.0 ± 0.05	4.0 ± 0.1	1.5 ^{+0.1} _{-0.0}	0.27	0.36	Angular Punch Hole
0201	0.37 ± 0.03	0.67 ± 0.05							0.45	0.80	
0402	0.65 ± 0.05	1.15 ± 0.05				4.0 ± 0.10			1.1	1.4	
0603	1.1 ± 0.2	1.9 ± 0.2									
0805	1.65 ± 0.2	2.4 ± 0.2									
1206	2.0 ± 0.2	3.6 ± 0.2									

PUNCHED CARRIER TAPE

