

FEATURES

- SHIELDED POWER INDUCTOR
- AUTOMATIC ASSEMBLY
- ROBUST CONSTRUCTION
- HIGH EFFICIENCY
- HIGHER CURRENT RATINGS COMPARED TO NPIS_Lx
- ULTRA LOW PROFILE (1.0 ~ 1.2mm HEIGHTS)
- SURFACE MOUNTABLE CONSTRUCTION
- TAPED AND REELED FOR AUTOMATIC INSERTION

RoHS
Compliant
includes all homogeneous materials

*See Part Number System for Details

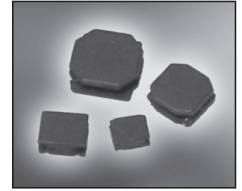

CHARACTERISTICS

Case Size	NPIM26L	NPIM20L	NPIM21L	NPIM31L
Inductance Range	0.24 ~ 10μH	0.24 ~ 33μH	0.24 ~ 10μH	0.47 ~ 10μH
Case Size	NPIM32L	NPIM40L	NPIM41L	
Inductance Range	0.33 ~ 10μH	0.33 ~ 10μH	0.33~ 10μH	
Ambient Operating Temperature Range	-40°C ~ +125°C (including self-heating)			
Temperature Rise at Irms	Maximum +40°C Temperature Rise			
Inductance Change at Isat	Maximum -30% Inductance Drop From Initial Measured Value			
Inductance Tolerance	±20% (M)			
Resistance to Solder Heat	+260°C for 10 seconds			

DIMENSIONS (mm)

Series	Component Dimensions					Land Pattern Dimensions				
	A	B	C	D	E	F	G	g'	H	I
NPIM26L	2.0 ± 0.3	1.6 ± 0.3	1.0 ± 0.1	1.10 ± 0.15	0.60 ± 0.2	0.6	2.3	/	1.7	/
NPIM20L	2.5 ± 0.3	2.0 ± 0.3	1.0 ± 0.1	1.80 ± 0.20	0.85 ± 0.2	0.8	2.6	/	2.1	/
NPIM21L	2.5 ± 0.3	2.0 ± 0.3	1.2 ± 0.1	1.80 ± 0.20	0.85 ± 0.2	0.8	2.6	/	2.1	/
NPIM31L	3.0 ± 0.2	3.0 ± 0.2	1.0 ± 0.1	2.65 ± 0.40	0.90 ± 0.2	/	/	2.2	2.7	0.8
NPIM32L	3.0 ± 0.2	3.0 ± 0.2	1.2 ± 0.1	2.65 ± 0.40	0.90 ± 0.2	/	/	2.2	2.7	0.8
NPIM40L	4.0 ± 0.2	4.0 ± 0.2	1.0 ± 0.1	3.30 ± 0.35	1.10 ± 0.2	/	/	2.8	3.7	1.2
NPIM41L	4.0 ± 0.2	4.0 ± 0.2	1.2 ± 0.1	3.30 ± 0.35	1.10 ± 0.2	/	/	2.8	3.7	1.2

NPIM26L, NPIM20L, NPIM21L
NPIM31L, NPIM32L, NPIM40L, NPIM41L

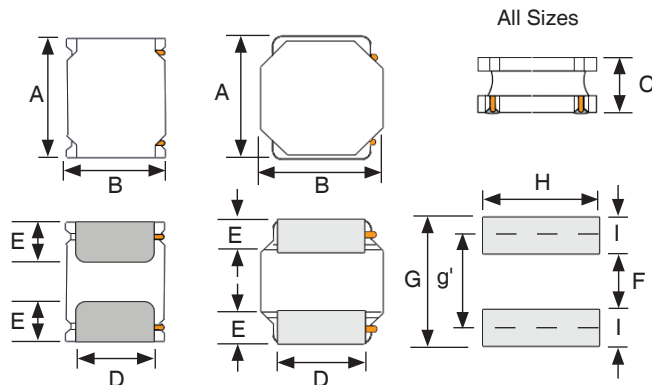

PART NUMBER SYSTEM

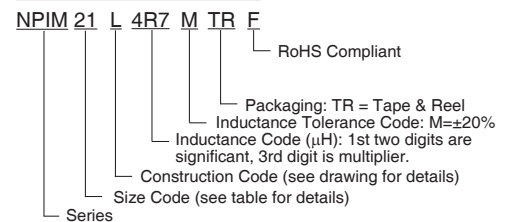

NPIM26L Size

Series	Standard Values - Case Size 26 (2.0x1.6x1.0mm)							
	Inductance (μH)	Test Conditions	DCR (Ω)		Isat (Amps)		IDC (Amps)	
			Max.	Typ.	Max.	Typ.	Max.	Typ.
NPIM26LR24MTRF	0.24 ± 20%	1MHz, 1V	0.034	0.028	5.60	6.60	4.00	4.50
NPIM26LR33MTRF	0.33 ± 20%		0.040	0.033	4.80	5.70	3.50	3.80
NPIM26LR47MTRF	0.47 ± 20%		0.048	0.040	3.60	4.30	3.40	3.60
NPIM26LR68MTRF	0.68 ± 20%		0.056	0.047	3.00	3.60	2.60	2.85
NPIM26L1R0MTRF	1.0 ± 20%		0.075	0.063	2.40	3.00	2.50	2.70
NPIM26L1R5MTRF	1.5 ± 20%		0.120	0.100	1.80	2.15	2.15	2.25
NPIM26L2R2MTRF	2.2 ± 20%		0.160	0.135	1.55	1.85	1.60	1.75
NPIM26L3R3MTRF	3.3 ± 20%		0.230	0.193	1.25	1.50	1.50	1.70
NPIM26L4R7MTRF	4.7 ± 20%		0.340	0.280	1.00	1.20	1.25	1.30
NPIM26L6R8MTRF	6.8 ± 20%		0.540	0.450	0.84	1.00	0.97	1.02
NPIM26L100MTRF	10 ± 20%		0.685	0.570	0.75	0.90	0.90	0.95

Maximum +40°C temperature rise at IDC. Maximum -30% inductance drop from initial measured value at Isat.

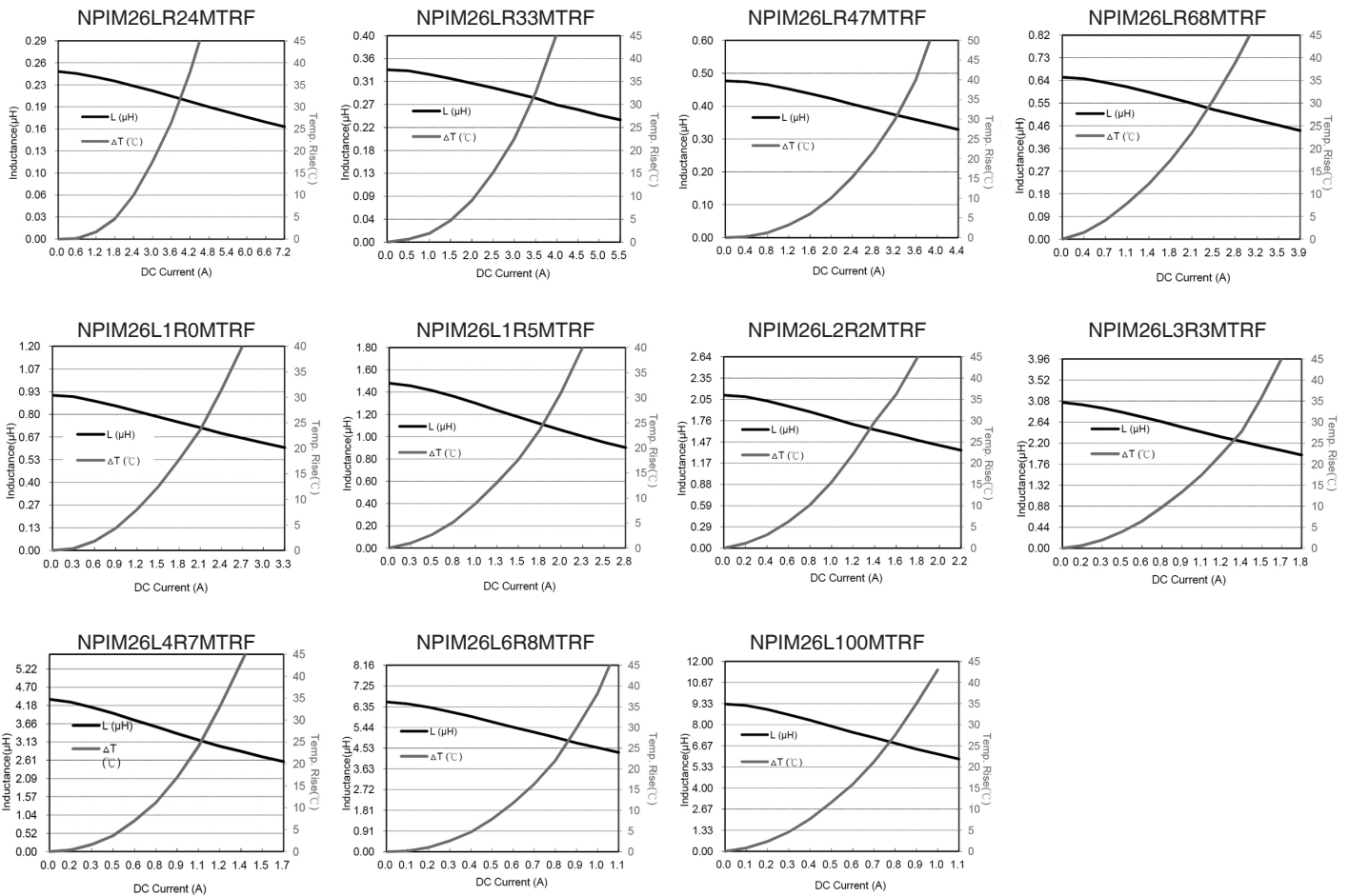

NPIM20L Size

Series	Standard Values - Case Size 20 (2.5x2.0x1.0mm)							
	Inductance (μH)	Test Conditions	DCR (Ω)		Isat (Amps)		IDC (Amps)	
			Max.	Typ.	Max.	Typ.	Max.	Typ.
NPIM20LR24MTRF	0.24 ± 20%	1MHz, 1V	0.0310	0.0265	6.80	8.10	4.10	4.30
NPIM20LR33MTRF	0.33 ± 20%		0.0360	0.0300	6.10	7.30	3.60	4.10
NPIM20LR47MTRF	0.47 ± 20%		0.0445	0.0370	5.50	6.60	3.10	3.60
NPIM20LR68MTRF	0.68 ± 20%		0.0620	0.0520	4.05	4.40	2.70	3.10
NPIM20L1R0MTRF	1.0 ± 20%		0.0800	0.0670	3.35	4.10	2.55	2.95
NPIM20L1R5MTRF	1.5 ± 20%		0.1060	0.0880	2.85	3.45	1.95	2.25
NPIM20L2R2MTRF	2.2 ± 20%		0.1500	0.1240	2.60	3.20	1.55	1.85
NPIM20L3R3MTRF	3.3 ± 20%		0.2220	0.1850	2.10	2.50	1.25	1.45
NPIM20L4R7MTRF	4.7 ± 20%		0.2900	0.2400	1.75	2.15	1.10	1.30
NPIM20L6R8MTRF	6.8 ± 20%		0.4350	0.3600	1.40	1.70	0.96	1.15
NPIM20L100MTRF	10 ± 20%	0.5300	0.4400	1.28	1.55	0.85	0.96	

Maximum +40°C temperature rise at IDC. Maximum -30% inductance drop from initial measured value at Isat.

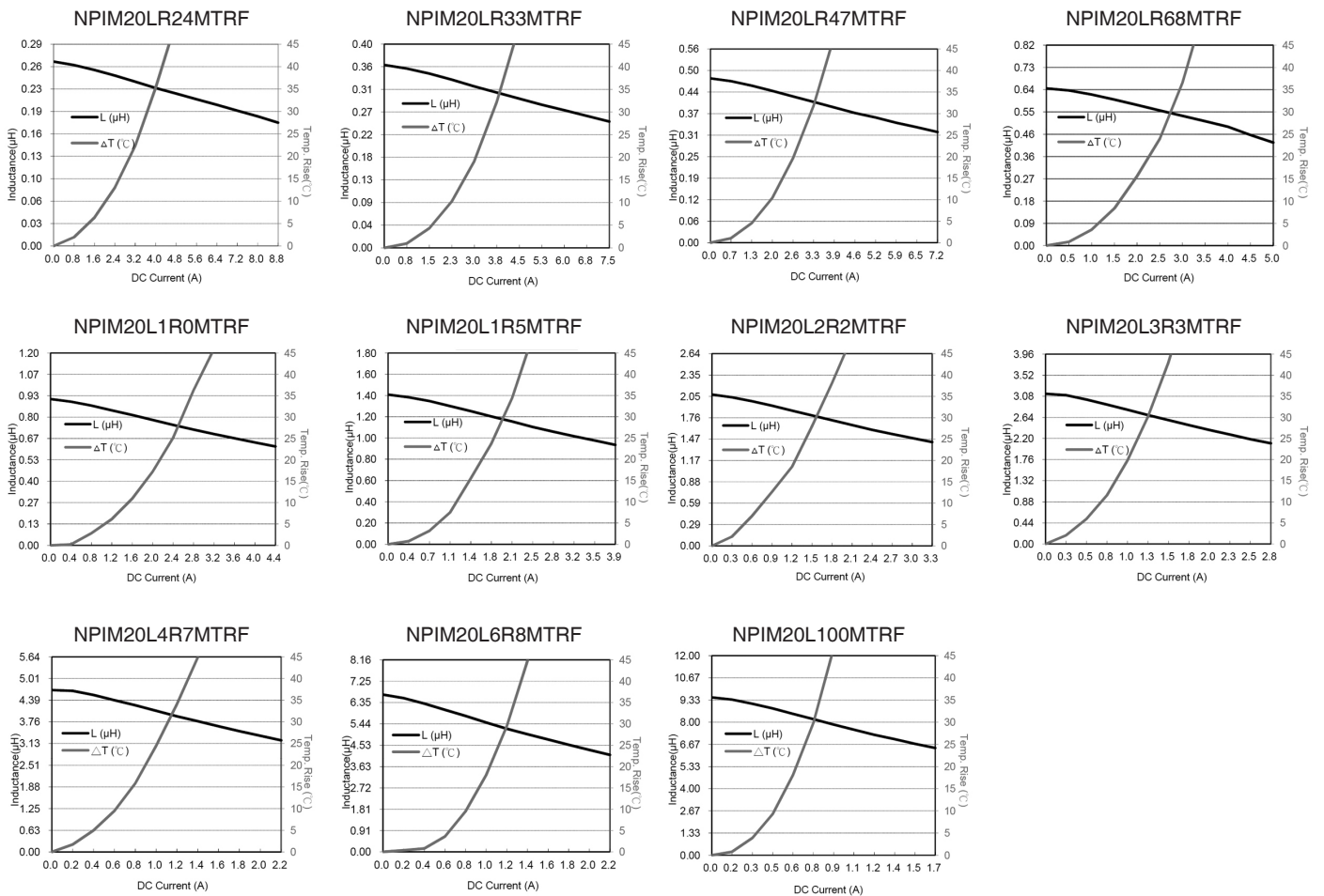

NPIM21L Size

Series	Standard Values - Case Size 21 (2.5x2.0x1.2mm)							
	Inductance (μH)	Test Conditions	DCR (Ω)		Isat (Amps)		IDC (Amps)	
			Max.	Typ.	Max.	Typ.	Max.	Typ.
NPIM21LR24MTRF	0.24 ± 20%	1MHz, 1V	0.0222	0.0185	5.90	7.10	4.40	4.80
NPIM21LR33MTRF	0.33 ± 20%		0.0300	0.0250	5.80	7.00	4.30	4.70
NPIM21LR47MTRF	0.47 ± 20%		0.0345	0.0285	4.60	5.50	4.20	4.60
NPIM21LR68MTRF	0.68 ± 20%		0.0402	0.0335	3.30	4.00	3.40	3.90
NPIM21L1R0MTRF	1.0 ± 20%		0.0555	0.0465	3.00	3.70	3.20	3.50
NPIM21L1R2MTRF	1.2 ± 20%		0.0685	0.0570	2.95	3.55	3.15	3.40
NPIM21L1R5MTRF	1.5 ± 20%		0.0800	0.0665	2.40	2.90	2.80	3.00
NPIM21L2R2MTRF	2.2 ± 20%		0.1110	0.0930	2.10	2.50	2.30	2.60
NPIM21L3R3MTRF	3.3 ± 20%		0.1540	0.1280	1.60	1.90	2.00	2.20
NPIM21L4R7MTRF	4.7 ± 20%		0.2300	0.1900	1.30	1.60	1.70	1.85
NPIM21L6R8MTRF	6.8 ± 20%		0.2650	0.2200	1.10	1.35	1.50	1.60
NPIM21L100MTRF	10 ± 20%		0.4150	0.3450	1.00	1.20	1.20	1.30

Maximum +40°C temperature rise at IDC. Maximum -30% inductance drop from initial measured value at Isat.

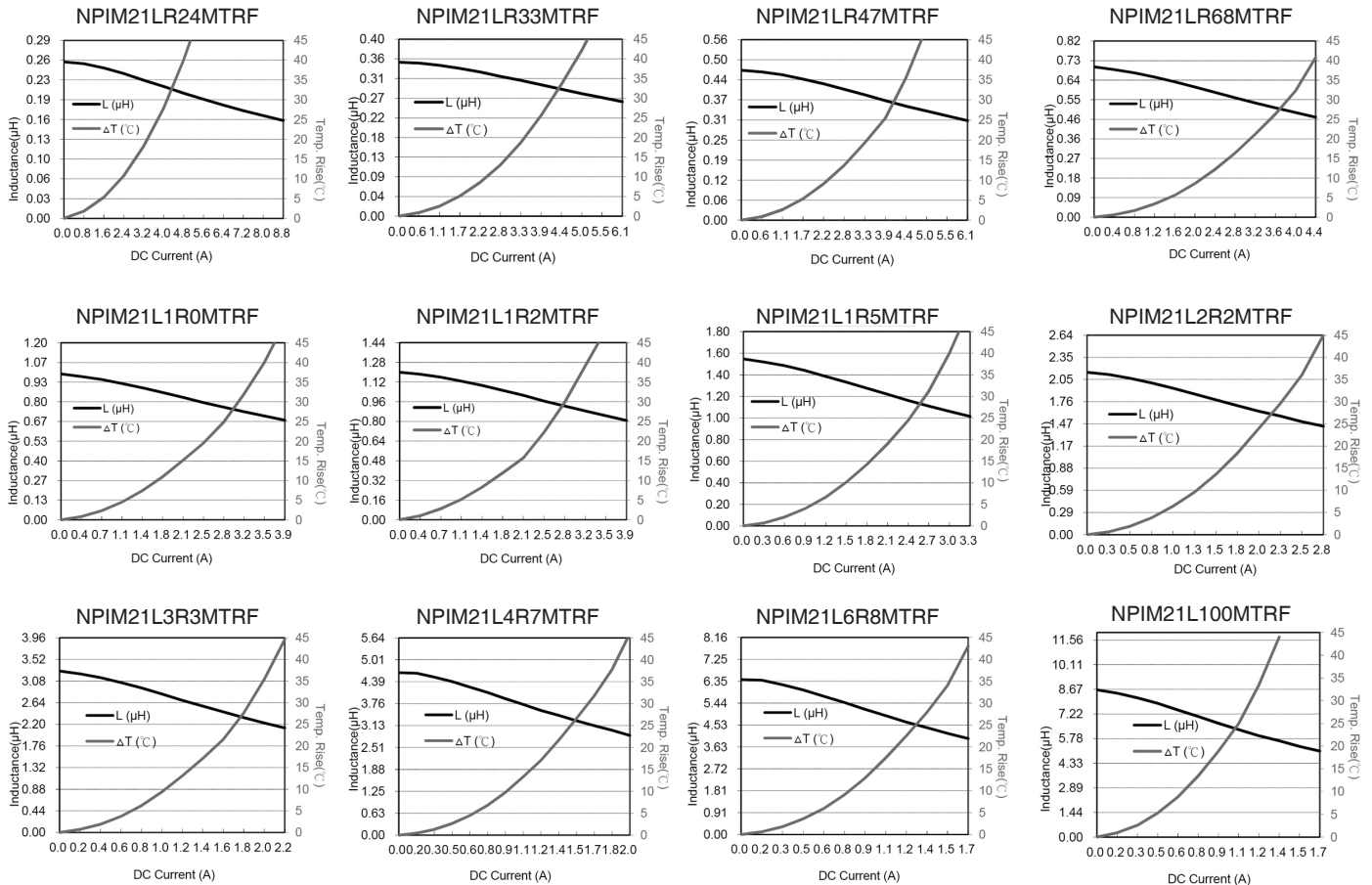

NPIM31L Size

Series	Standard Values - Case Size 31 (3.0x3.0x1.0mm)							
	Inductance (μH)	Test Conditions	DCR (Ω)		Isat (Amps)		IDC (Amps)	
			Max.	Typ.	Max.	Typ.	Max.	Typ.
NPIM31LR47MTRF	0.47 ± 20%	1MHz, 1V	0.038	0.031	5.7	6.7	3.60	4.10
NPIM31LR68MTRF	0.68 ± 20%		0.053	0.044	4.8	5.7	3.40	3.90
NPIM31L1R0MTRF	1.0 ± 20%		0.068	0.057	4.5	5.2	2.70	3.10
NPIM31L1R5MTRF	1.5 ± 20%		0.091	0.076	3.9	4.5	2.60	2.90
NPIM31L2R2MTRF	2.2 ± 20%		0.115	0.096	3.4	3.9	2.20	2.50
NPIM31L3R3MTRF	3.3 ± 20%		0.175	0.145	2.7	3.2	1.70	1.90
NPIM31L4R7MTRF	4.7 ± 20%		0.265	0.220	2.1	2.4	1.30	1.50
NPIM31L6R8MTRF	6.8 ± 20%		0.384	0.320	1.8	2.1	1.15	1.35
NPIM31L100MTRF	10 ± 20%		0.540	0.450	1.3	1.6	0.95	1.10

Maximum +40°C temperature rise at IDC. Maximum -30% inductance drop from initial measured value at Isat.

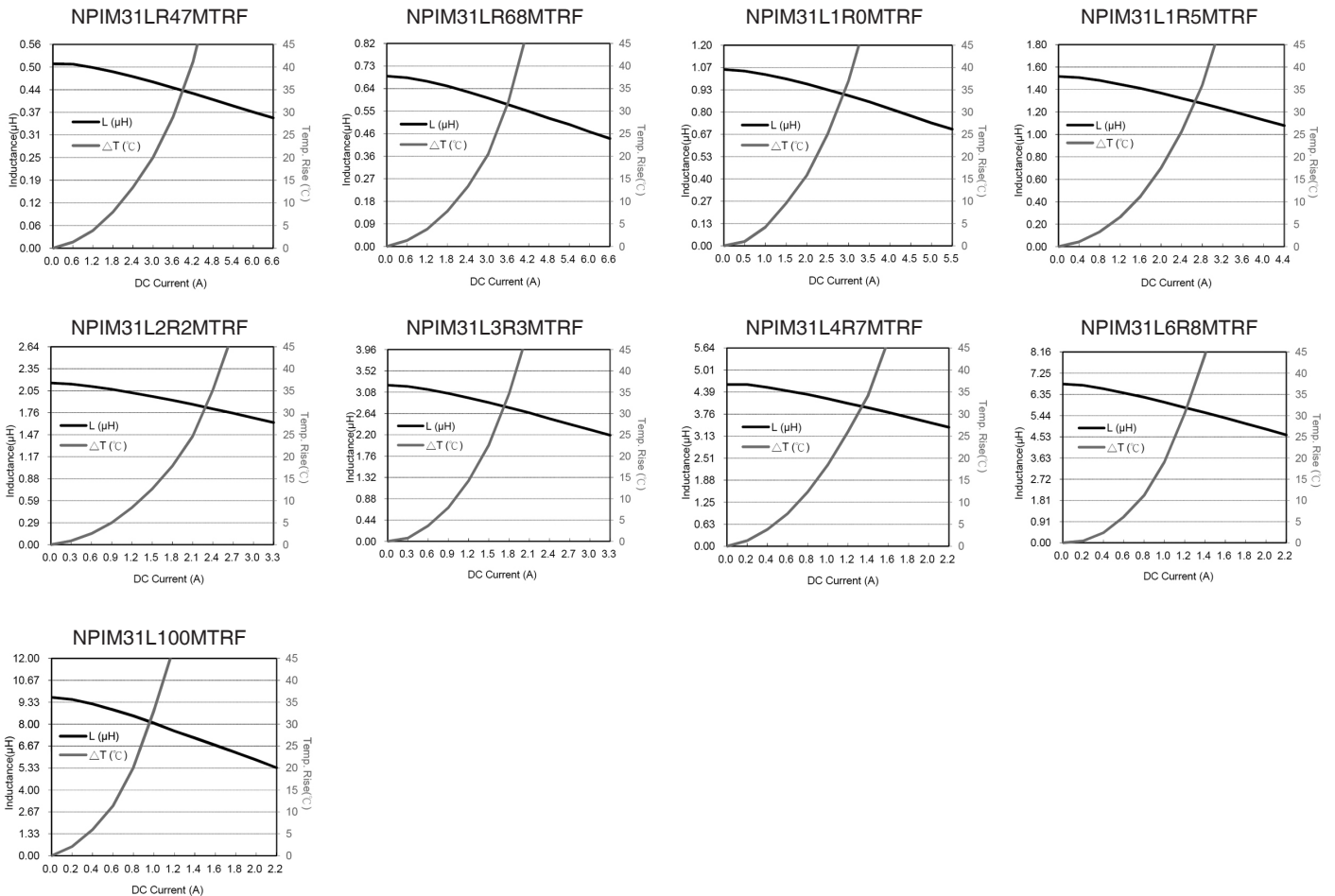

NPIM32L Size

Series	Standard Values - Case Size 32 (3.0x3.0x1.2mm)							
	Inductance (μH)	Test Conditions	DCR (Ω)		Isat (Amps)		IDC (Amps)	
			Max.	Typ.	Max.	Typ.	Max.	Typ.
NPIM32LR33MTRF	0.33 ± 20%	1MHz, 1V	0.0220	0.018	7.30	8.6	4.80	6.40
NPIM32LR47MTRF	0.47 ± 20%		0.0255	0.021	6.40	7.5	4.20	5.00
NPIM32L1R0MTRF	1.0 ± 20%		0.0495	0.041	4.90	5.7	3.20	3.90
NPIM32L1R5MTRF	1.5 ± 20%		0.0740	0.063	4.50	5.1	2.60	3.00
NPIM32L2R2MTRF	2.2 ± 20%		0.1100	0.091	3.50	4.1	2.20	2.40
NPIM32L3R3MTRF	3.3 ± 20%		0.1500	0.125	2.60	3.0	1.80	2.10
NPIM32L4R7MTRF	4.7 ± 20%		0.2050	0.170	2.10	2.5	1.35	1.55
NPIM32L6R8MTRF	6.8 ± 20%		0.2900	0.240	1.85	2.2	1.10	1.30
NPIM32L100MTRF	10 ± 20%		0.3450	0.290	1.45	1.7	1.05	1.25

Maximum +40°C temperature rise at IDC. Maximum -30% inductance drop from initial measured value at Isat.

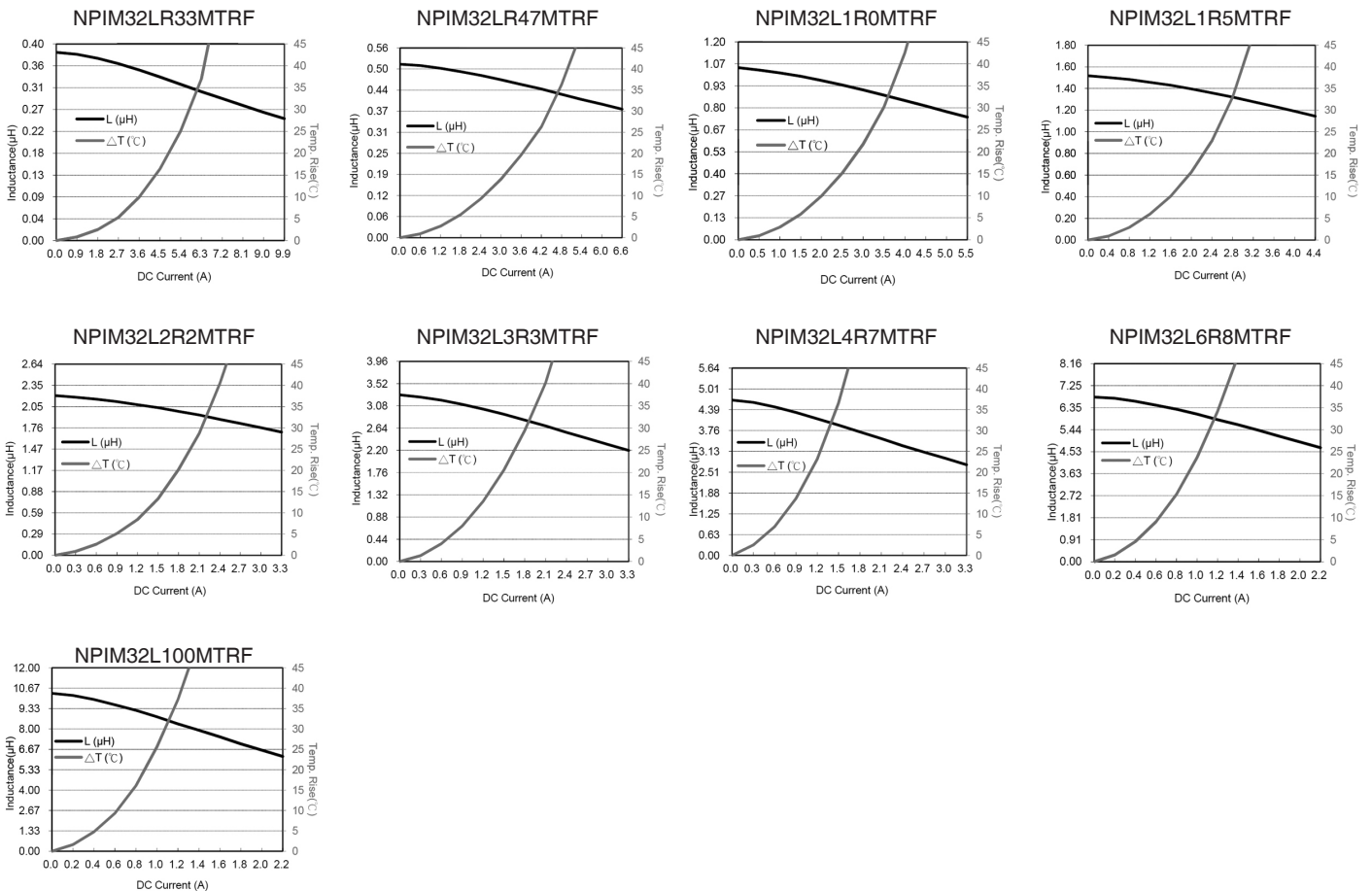

NPIM40L Size

Series	Standard Values - Case Size 40 (4.0x4.0x1.0mm)							
	Inductance (μH)	Test Conditions	DCR (Ω)		Isat (Amps)		IDC (Amps)	
			Max.	Typ.	Max.	Typ.	Max.	Typ.
NPIM40LR33MTRF	0.33 ± 20%	1MHz, 1V	0.0190	0.0155	7.40	8.70	5.00	5.80
NPIM40LR47MTRF	0.47 ± 20%		0.0240	0.0200	6.40	7.90	4.70	5.50
NPIM40LR68MTRF	0.68 ± 20%		0.0340	0.0280	5.30	6.30	3.40	3.90
NPIM40L1R0MTRF	1.0 ± 20%		0.0540	0.0450	4.70	5.70	3.00	3.50
NPIM40L1R5MTRF	1.5 ± 20%		0.0745	0.0620	3.55	4.20	2.70	3.10
NPIM40L2R2MTRF	2.2 ± 20%		0.1080	0.0900	3.00	3.60	2.40	2.70
NPIM40L3R3MTRF	3.3 ± 20%		0.1740	0.1450	2.40	2.80	1.80	2.00
NPIM40L4R7MTRF	4.7 ± 20%		0.2050	0.1750	2.05	2.45	1.60	1.90
NPIM40L6R8MTRF	6.8 ± 20%		0.2800	0.2300	1.70	2.00	1.35	1.55
NPIM40L100MTRF	10 ± 20%		0.3900	0.3250	1.40	1.70	1.10	1.30

Maximum +40°C temperature rise at IDC. Maximum -30% inductance drop from initial measured value at Isat.

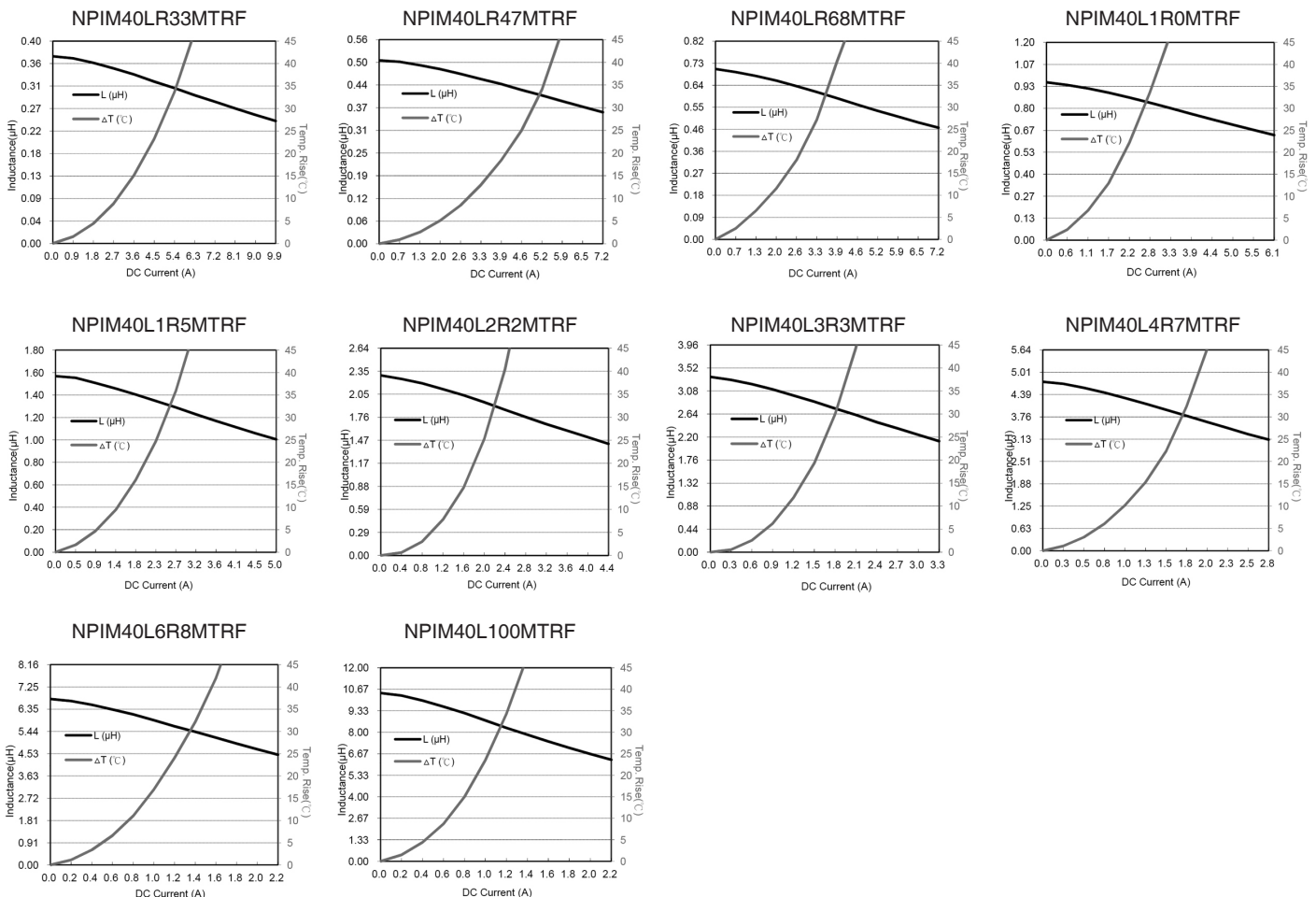

NPIM41L Size

Series	Standard Values - Case Size 41 (4.0x4.0x1.2mm)							
	Inductance (μH)	Test Conditions	DCR (Ω)		Isat (Amps)		IDC (Amps)	
			Max.	Typ.	Max.	Typ.	Max.	Typ.
NPIM41LR33MTRF	0.33 ± 20%	1MHz, 1V	0.017	0.013	9.10	10.8	6.10	7.00
NPIM41LR47MTRF	0.47 ± 20%		0.019	0.016	8.20	10.0	4.80	5.60
NPIM41LR68MTRF	0.68 ± 20%		0.026	0.022	7.10	8.2	4.00	4.60
NPIM41L1R0MTRF	1.0 ± 20%		0.035	0.029	5.20	6.2	3.90	4.50
NPIM41L1R5MTRF	1.5 ± 20%		0.054	0.045	4.50	5.6	3.30	3.60
NPIM41L2R2MTRF	2.2 ± 20%		0.078	0.065	3.90	4.6	2.80	3.20
NPIM41L3R3MTRF	3.3 ± 20%		0.125	0.103	3.20	4.0	2.25	2.60
NPIM41L4R7MTRF	4.7 ± 20%		0.145	0.125	2.55	3.1	1.95	2.25
NPIM41L6R8MTRF	6.8 ± 20%		0.220	0.190	2.10	2.5	1.65	1.85
NPIM41L100MTRF	10 ± 20%		0.300	0.250	1.70	2.0	1.45	1.65

Maximum +40°C temperature rise at IDC. Maximum -30% inductance drop from initial measured value at Isat.

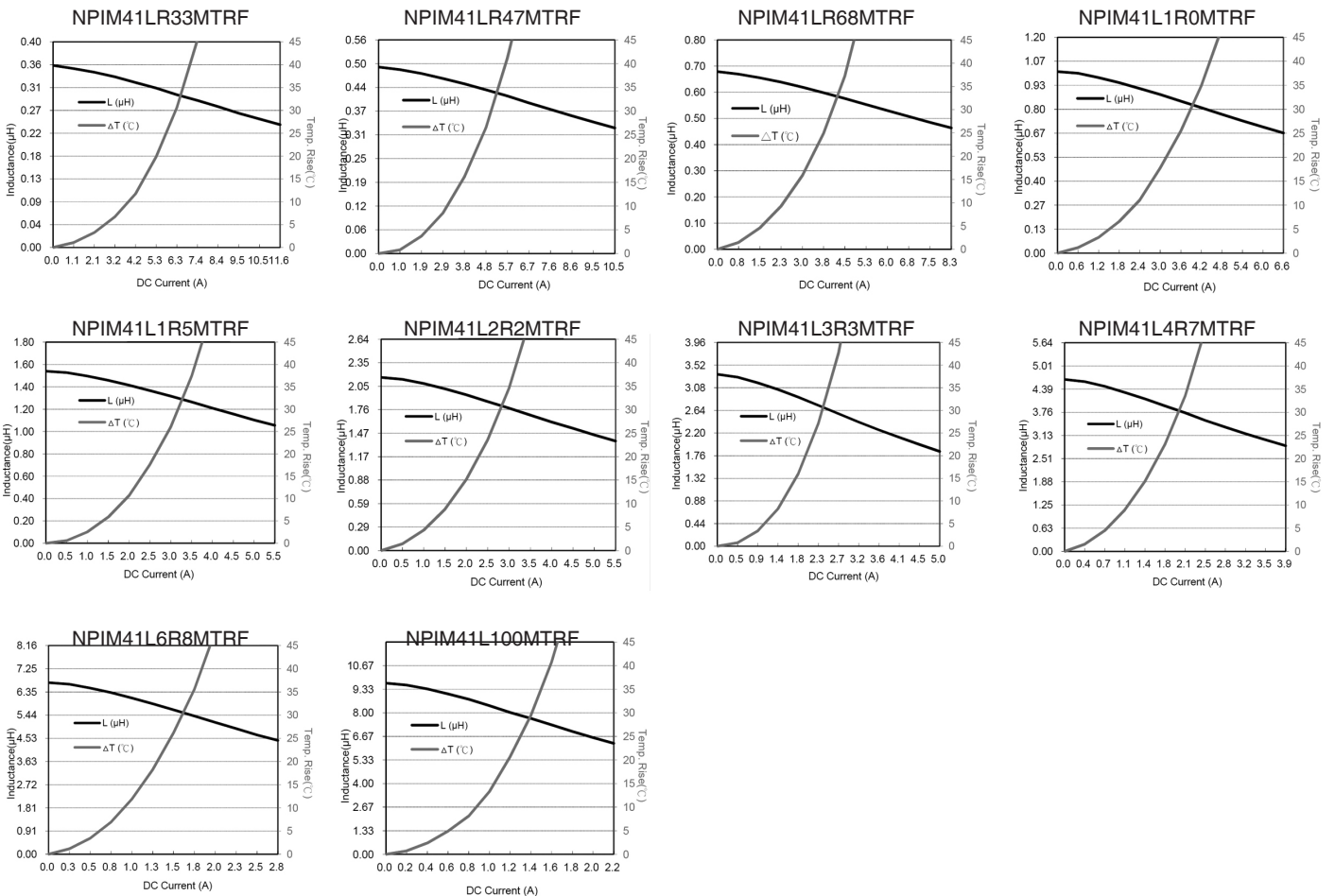

Case Size	CARRIER TAPING DIMENSIONS (mm) AND REEL QUANTITY							
	Ao	Bo	Ko	Co	W	Po	t	Quantity
NPIM26L	1.84 ± 0.1	2.25 ± 0.1	1.15 ± 0.1	3.5 ± 0.05	8.0 ± 0.1	4.0 ± 0.1	0.22 ± 0.05	3,000
NPIM20L	2.45 ± 0.1	3.1 ± 0.1	1.4 ± 0.1	3.5 ± 0.05	8.0 ± 0.1	4.0 ± 0.1	0.23 ± 0.05	3,000
NPIM21L								
NPIM31L	3.26 ± 0.1	3.4 ± 0.1	1.4 ± 0.1	3.5 ± 0.1	8.0 ± 0.3	4.0 ± 0.1	0.3 ± 0.05	2,000
NPIM32L								
NPIM40L	4.3 ± 0.1	4.3 ± 0.1	1.6 ± 0.1	5.5 ± 0.1	12.0 ± 0.3	8.0 ± 0.1	0.3 ± 0.05	1,000
NPIM41L								

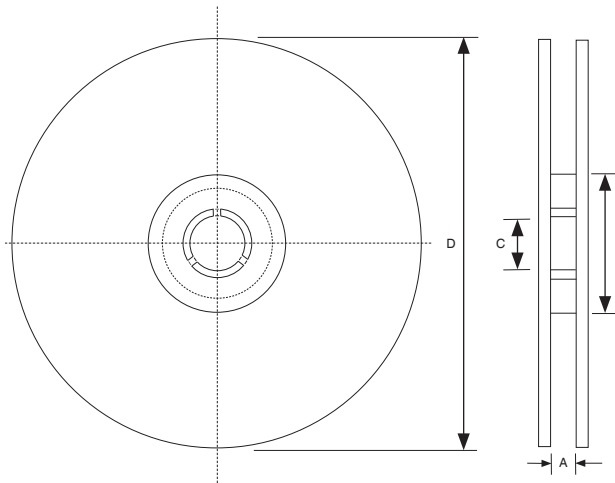
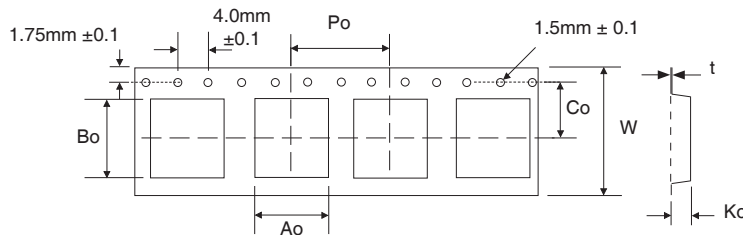

Tape Width	REEL DIMENSIONS (mm)			
	A(mm)	B(mm)	C(mm)	D(mm)
NPIM26L	8.4 ± 0.2/-0.1	62.0 ± 1.5	13.5 ± 0.5	180 ± 3.0
NPIM20L				
NPIM21L				
NPIM31L				
NPIM32L				
NPIM40L				
NPIM41L				

